

P52 Stainless Steel Regulator and Filter/Regulator

Features

- Low Droop
- Tapped Vent
- Excellent Stability
- Port Sizes from 1/8" up to 1"

Applications

- Sour Gas
- Corrosive Environments
- Off Shore

The P52SS regulator is designed for service with a wide variety of corrosive gases and severe environments. It is the ideal choice for sour gas applications and where a corrosive environment is present.

The standard version of this regulator is relieving with no constant bleed. You must specify if a non-relieving regulator is required.

Key components to the filter / regulator include a built in dripwell, 25 micron stainless filter. Both the regulator and filter / regulator come standard with Viton elastomers and a 'T' handle adjustment.



P52SS Part Matrix

P052SS		↑	↑	↑	↑	Style
RX						Regulator
FR						Filter Regulator with Manual Drain
AR						Filter Reg with Auto Drain
						Body Size
	02					1/4 NPT
	03					3/8 NPT
	04					1/2 NPT
	06					3/4 NPT
	08					1 NPT
						Output Ranges
	030					0 - 30 PSIG
	060					6 - 60 PSIG
	125					12 - 125 PSIG
	150					15 - 150 PSIG
						Options
	00					Standard
	0B					Non-relieving
	0F					5 Micron Filter
	BF					Non-relieving & 5 Micron Filter
						Hex Head Adjustment
						Non-relieving Hex Head Adjustment
						5 Micron Filter and Hex Head
						Non-relieving Hex Head and 5 Micron Filter

Specifications

Maximum Inlet Pressure	425 PSIG
Outlet Ranges	3 - 30 PSIG
	6 - 60 PSIG
	12 - 125 PSIG
	15 - 150 PSIG
Repeatability	± 0.25 PSIG
Flow Rates at 100 PSIG Inlet 20 PSIG Outlet	1/4" - 38 SCFM
	3/8" - 42 SCFM
	1/2" - 95 SCFM
	3/4" - 105 SCFM
	1" - 105 SCFM
Temperature Range	-4 to 176 °F
Exhaust Capacity	0.1 SCFM
Air Consumption	0.5 SCFH
Filter	25 Micron
Supply Pressure Sensitivity at 25 PSIG	± 1.0 PSIG Change in Output
Material	316 SS Housing Body and Filter Viton Elastomers

P52 Stainless Steel Dimensions

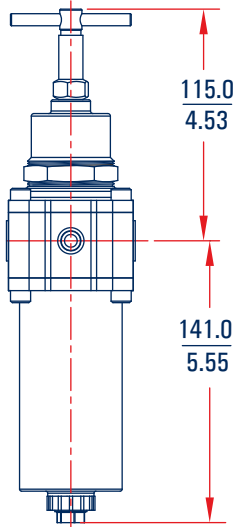

P52SSAR 1/4" & 3/8"

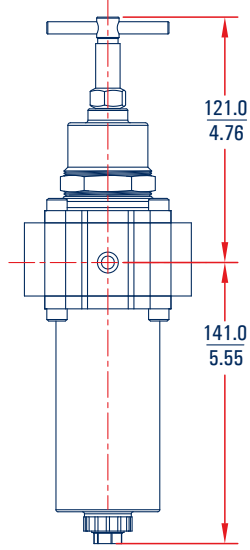

P52SSAR 1/2", 3/4"

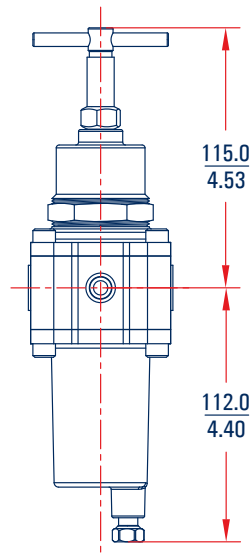

P52SSFR 1/4" & 3/8"

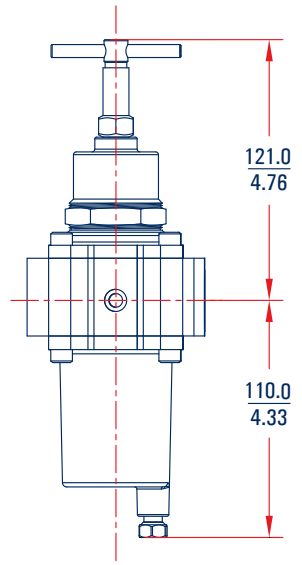

P52SSFR 1/2", 3/4"

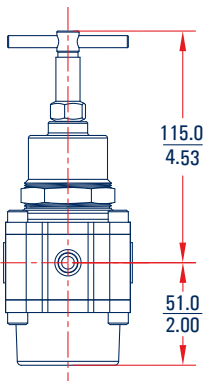

P52SSSR 1/4" & 3/8"

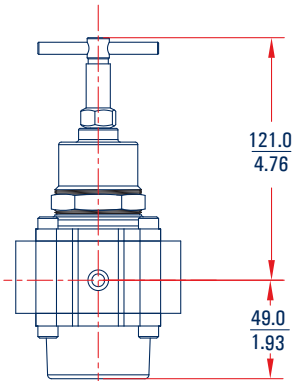

P52SSSR 1/2", 3/4"

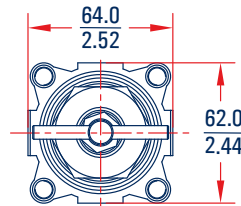

1/4" & 3/8"

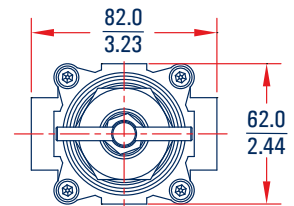

1/2", 3/4"

Mounting Bracket
607-309-000

mm
inches

